

Montgomery Ward™

Montgomery Ward™

Easy-to-use control panel with multiple settings

Portable Countertop Dishwasher



Instruction Manual

MODEL: FD051B_MW
120V~, 60Hz, 680W

Montgomery Ward Customer Service
3650 Milwaukee Street, Madison, WI 53714
8:00 am to Midnight, Monday through Friday

Wards.com 1-888-557-3848

Wards.com 1-888-557-3848



Thank you for purchasing your Portable Countertop Dishwasher by Montgomery Ward™. We guarantee that it will perform to the highest standard, time after time, with all the convenience, easy cleanup and durability you rely on from Wards.

The luxury of a dishwasher in a portable, compact size for everyday use. You'll enjoy its many benefits for years to come, from saving time and energy to reduced kitchen clutter, and the easy control panel with multiple settings and digital display. And perhaps most of all, you'll savor the peace of mind that comes with a clean you just can't get from hand washing.

Table of Contents

Important Safeguards.....	3-4
Grounding Instructions	4
Parts & Features.....	5-6
About Your Dishwasher.....	7-9
Loading Your Dishwasher	10-11
How to Use	12-14
Cleaning & Care	14-17
Installation	18-21
Before Using.....	21
Troubleshooting	22-24
Error Codes	25
Warranty & Return Information.....	26-27

PLEASE SAVE THESE INSTRUCTIONS

THIS APPLIANCE IS FOR HOUSEHOLD USE ONLY

© 2014 Montgomery Ward, Inc. All rights reserved.

Important Safeguards

PLEASE READ THESE INSTRUCTIONS BEFORE USE

Basic safety precautions should always be followed when using your Countertop Dishwasher, especially when children are present.

WARNING: TO AVOID THE RISK OF ELECTRICAL SHOCK, ALWAYS MAKE SURE THE PRODUCT IS UNPLUGGED FROM THE ELECTRICAL OUTLET BEFORE ASSEMBLING, DISASSEMBLING, RELOCATING, SERVICING OR CLEANING

1. Do NOT place any heavy objects on the door, or press down, when it is open or it could tip forward.
2. When using your dishwasher, you should prevent plastic items from coming into contact with interior walls of the dishwasher.
3. Do NOT operate your dishwasher unless all enclosure panels are properly in place. Open the door very carefully if the dishwasher is operating, there is a risk of water squirting out.
4. When loading items to be washed, make sure sharp items are in a position so as to not damage the door seal.

WARNING: Knives and other utensils with sharp points must be loaded in the basket with their points down or placed in a horizontal position.

5. Check that the detergent receptacle is empty after completion of the wash cycle.
6. Do NOT wash plastic items unless they are marked "dishwasher safe" or the equivalent. For plastic items not marked "dishwasher safe", check the manufacturer's recommendations.
7. Use only detergent and rinse additives designed for an automatic dishwasher.
8. NEVER use soap, laundry detergent or hand washing detergent in your dishwasher. Keep these products out of the reach of children.
9. This appliance is not intended for use by persons (including children) with reduced physical, sensory or mental capabilities, or lack of experience and knowledge, unless they have been given supervision or instruction concerning use of the appliance by a person responsible for their safety.
10. Children should be supervised to ensure that they do not play with the appliance.

Important Safeguards (cont'd)

11. The door should not be left in the fully open position as the corners could catch loose clothing and the dishwasher could be pulled off of the counter.
12. If the power cord, or dishwasher, is damaged or malfunctions, call our toll-free number for information on replacement or return.
13. Please dispose of packing materials properly.
14. Use this dishwasher only for its intended purpose.
15. During installation, the power supply cord must not be excessively or dangerously bent or flattened.
16. This dishwasher must be connected to a water faucet with the supplied hose assembly (p. 20).
17. The maximum permissible inlet water pressure is 1Mpa.
18. The minimum permissible inlet water pressure is 0.04Mpa.

Grounding Instructions

This appliance has a 3-prong polarized plug.

1. This appliance must be grounded. In the event of a malfunction or breakdown, grounding will reduce the risk of electric shock by providing a path of least resistance for the electrical current. This appliance is equipped with a cord that has an equipment-grounding conductor and a grounding plug.
2. The plug must be plugged into an appropriate outlet that is installed and grounded in accordance with all local codes and ordinances.
3. Improper connection of the equipment-grounding conductor can result in a risk of electrical shock.
4. Check with a qualified electrician or service representative if you are in doubt whether the appliance is properly grounded. Do NOT modify the plug provided with the appliance. If it is not fit for the outlet, have a proper outlet installed by a qualified electrician.

Parts & Features

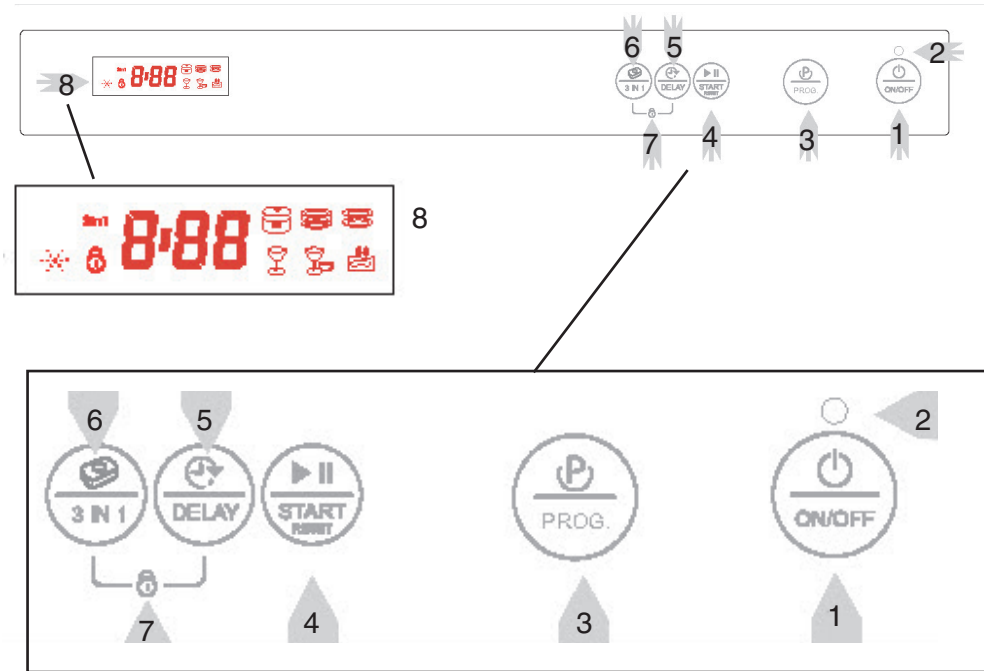

Control Panel:

1. Power button: to turn the power supply on/off
2. Power light: alerts you when power supply is on (lit) or off (dark)
3. Washing Program Selector: to select wash cycles
4. Start/Reset button: to start or pause the dishwasher
5. Delay button: to delay start time (0–24 hours)
6. 3-in-1 Function button: if you are using a 3-in-1 tablet instead of salt and rinse-aid
7. Child Lock function: allows you to press 3-in-1 function and delay buttons at the same time
8. Display: shows delay time, rinse-aid warming, countdown of washing cycle, wash program selected, child lock function, 3-in-1 function, etc.

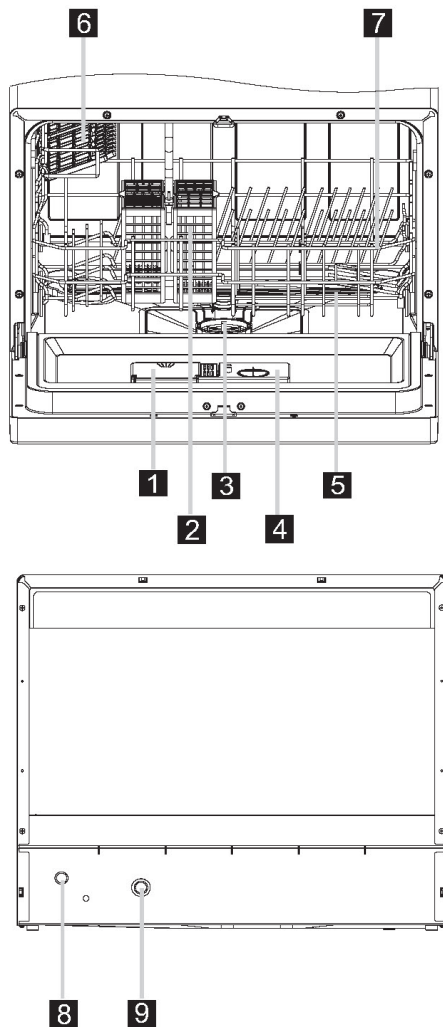

- | | | | | |
|------------------------------|------------------------------|---------------------|-------------------------------|-------------------------------|
| 1 Detergent Dispenser | 3 Filter assembly | 5 Spray Arms | 7 Basket | 9 Inlet pipe connector |
| 2 Cutlery Basket | 4 Rinse Aid Dispenser | 6 Cup Shelf | 8 Drain pipe connector | |

Rinse-Aid

The rinse-aid is released during the final rinse to prevent water from forming droplets on your dishes that can leave spots and streaks. It also improves drying by allowing water to sheet off the dishes.

Your dishwasher is designed to use liquid rinse-aids. The rinse-aid dispenser is located inside the door next to the detergent dispenser. To fill the dispenser, open the cap and pour rinse-aid into the dishwasher until the level indicator turns completely black. The volume of the rinse-aid dispenser is 2 fl. oz.

Only use branded rinse-aid for the dishwasher. NEVER fill the rinse-aid dispenser with any other substances (e.g. dishwasher cleaning agent, liquid detergent). This will damage the appliance.

When to refill the rinse-aid dispenser:

If there is no rinse-aid warning light in the control panel, you can judge the amount of rinse-aid by the color of the optical level indicator (C) located next to the cap. When the rinse-aid container is full, the whole indicator will be dark. As the rinse-aid diminishes, the size of the dark dot decreases. You should never let the rinse-aid get below 1/4 full.

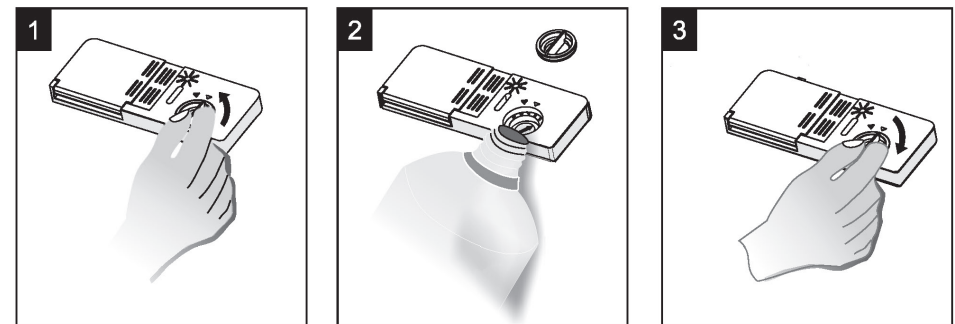
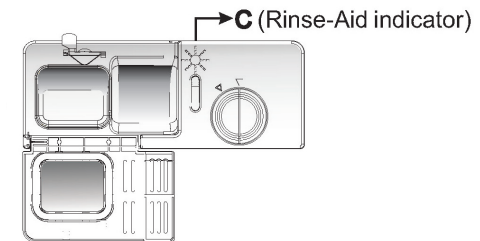

1. To open the dispenser, turn the cap to the "open" (left) arrow and lift it out.
2. Pour the rinse-aid into the dispenser, being careful not to overfill.
3. Replace the cap by inserting it aligned with "open" (left) arrow and turning it to the "closed" (right) arrow.

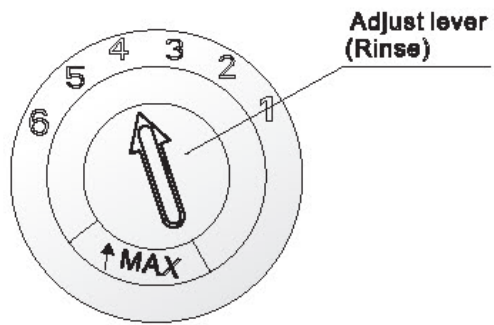

The rinse-aid dispenser has 4 settings. Always start with the dispenser set on '1'. If spots and poor drying occur, increase the amount of rinse-aid dispensed by removing the dispenser lid and rotating the dial to '5'. If the dishes are still not drying properly or are spotted, adjust the dial to the next higher number until your dishes are spot-free. The recommended setting is '4'.

Detergents

There are 3 types of detergents:

1. With phosphate and chlorine
2. With phosphate but without chlorine
3. Without phosphate or chlorine

Function of detergent:

Detergent, with its chemical ingredients, is necessary to remove, crush and transport dirt out of the dishwasher. Use only detergent specifically made for use in dishwashers. Keep your detergent fresh and dry. Don't put powder detergent into the dispenser until you're ready to wash dishes.

Normally new pulverized detergent does not have phosphate and the water softening function of phosphate is not available. If detergents without phosphate are used with hard water, often white spots appear on dishes and glasses. In this case, please add more detergent to achieve better results.

Detergents without chlorine only bleach a little. Strong and colored spots will not be removed completely. If this happens, choose a washing cycle with a higher temperature.

Concentrated detergent

Based on their chemical composition, dishwasher detergents can be split in two basic types:

1. Conventional, alkaline detergents with caustic components
2. Low alkaline concentrated detergents with natural enzymes

The use of "normal" washing cycles in conjunction with concentrated detergents reduces pollution and is good for your dishes; these cycles are specially matched to the dirt-dissolving properties of the enzymes of the concentrated detergent. For this reason, "normal" wash cycles in which concentrated detergents are used can achieve the same results that can otherwise only be achieved using "intensive" cycles.

Detergent Tablets

Detergent tablets of different brands dissolve at different speeds. For this reason, some tablets cannot dissolve and develop their full cleaning power during short cycles. Please use long cycles when using detergent tablets to ensure the complete removal of detergent residuals.

****NOTE:** Detergent tablets are only for use with models that have a 3-in-1 function.

Detergent Dispenser

The dispenser must be refilled before the start of each wash cycle following the instructions provided in the "Wash Cycle Table" on p. 12. Your dishwasher uses less detergent and rinse-aid than a conventional dishwasher. Generally, only one tablespoon of detergent is needed for a normal wash cycle. More heavily soiled items need more detergent. Always add the detergent just before starting the dishwasher, otherwise the detergent could become damp and will not dissolve properly.

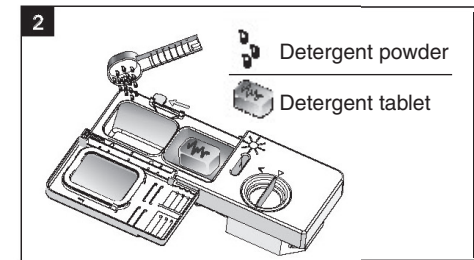
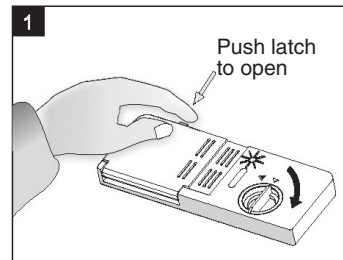

Warning! Dishwasher detergent is corrosive. Take care to keep out of reach of children.

Filling the Detergent Dispenser:

Fill the detergent dispenser with detergent. The marking indicates the fill levels, as illustrated on the right.

15 Fill with main wash cycle detergent.

25 Fill with pre-wash cycle detergent

Please observe the manufacturer's dosing and storage recommendations as stated on the detergent packaging.

Close the lid and press until it locks in place.

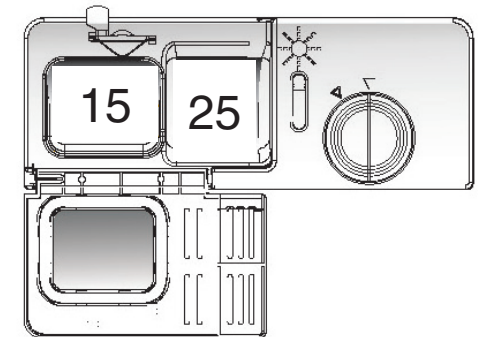

Recommendation:

- Consider buying utensils that are identified as dishwasher safe.
- Use a mild detergent that is described as “kind to dishes”. If necessary, seek further information from detergent manufacturers.
- For particular items, select a cycle with as low a temperature as possible.
- To prevent damage, do not take glass and cutlery out of the dishwasher immediately after the cycle has ended.

Dishes you shouldn't wash in the dishwasher:

NOT Suitable	Limited Suitability
Cutlery with wood, horn china or mother-of-pearl handles	Some types of glasses can become dull after a large number of washes
Plastic items that are not heat-resistant	Silver and aluminum parts have a tendency to discolor during washing
Older cutlery with glued parts that are not heat-resistant	Decal and hand-painted patterns may fade if washed in the dishwasher frequently
Bonded cutlery items or dishes	
Pewter or copper items	
Crystal glass	
Steel items subject to rusting	
Wooden platters	
Items made from synthetic fibers	

Loading guidelines:

For best performance of the dishwasher, follow these loading guidelines. (Features and appearance of baskets and cutlery baskets may vary from your model.)

Scrape off any large amounts of leftover food. Soften remnants of burnt food in pans. It is not necessary to rinse the dishes under running water. Place objects in the dishwasher as follows:

1. Items such as cups, glasses, pots/pans, etc. are face down.
2. Curved items, or those with recesses, should be loaded at a slant so that water can run off.
3. All utensils should be stacked securely so they cannot tip over.
4. All utensils should be placed so that the spray arms can rotate freely during washing.

- Load hollow items such as cups, glasses, pans, etc. with the opening downwards so that water cannot collect in the container or a deep base.
- Dishes and cutlery must not lie inside one another, or cover each other.
- To avoid damage to glasses, they must not touch.
- Load large items that are most difficult to clean into the basket.
- Long bladed knives placed in an upright position are a potential hazard!
- Long and/or sharp items of cutlery, such as carving knives must be positioned horizontally in the basket.
- Please do not overload your dishwasher. This is important for good results and reasonable energy consumption.
- The number of dinnerware items will vary due to their size and shape. Position the dinnerware so it is best suited for cleaning.

Cutlery should be placed in the cutlery basket with handles at the bottom. If the rack has side baskets, spoons should be loaded individually into appropriate slots. Long utensils should be placed in the horizontal position at the front of the upper basket.







- Do NOT let any item extend through the bottom
- Always load sharp utensils with the sharp point down

For personal safety and a top-quality clean, place the silverware in the basket:

- So that they do not nest together
- Handles down, except knives and other potentially dangerous utensils should be handles up

Wash Cycle Table

- NOTE:**
- (★) Means: need to fill rinse into the Rinse-Aid Dispenser.
 - *AHAM DW-1-2005 : This program is the test cycle, the rinse-aid dispenser setting is recommended to Position 6.

Program	Cycle Selection Information	Description of Cycle	Detergent pre/main	Running time(min)	Energy (wh)	Water (Gal)	Rinse Aid
 Heavy	For the heaviest soiled loads, such as pots, pans, casserole dishes and dishes that have been sitting with dried food on them for a while.	Pre-wash Pre-wash(122° F) Wash(131° F) Wash(122° F) Rinse Rinse(149° F) Drying	0.63 oz	100	424	3.83	★
 Normal	For normally soiled loads, such as pots, plates, glasses and lightly soiled pans. standard daily cycle.	Pre-wash Pre-wash Wash(131° F) Rinse Rinse(149° F) Drying	0.63 oz	85	361	3.17	★
(*AHAM DW-1-2005)							
 Light	For lightly soiled loads, such as plates, glasses, bowls and lightly soiled pans.	Pre-wash Pre-wash(122° F) Wash(122° F) Rinse Rinse(140° F) Drying	0.63 oz	75	311	3.17	★
 Glass	For lightly soiled loads, such as glasses, crystal and fine china.	Pre-wash Wash(122° F) Rinse Rinse(140° F) Drying	0.53 oz	70	274	2.56	★
 Speed	A shorter wash for lightly soiled loads that do not need drying.	Pre-wash Pre-wash(122° F) Wash(122° F) Rinse Rinse(131° F)	0.53 oz	45	233	3.17	
 Soak	To rinse dishes that you plan to wash later that day.	Pre-wash	/	10	10	0.66	

Starting a wash cycle:

1. Draw out the basket (see “Loading Your Dishwasher”, p. 10)
2. Add detergent (see p. 9)
3. Plug in your dishwasher.
4. Connect the quick-disconnect to the faucet adapter. Make sure the hot water supply is turned on to full pressure.
5. Close the door and press “ON/OFF” to turn on the power supply.
6. Press “PROG.” to select the wash cycle you need.
Heavy -> Normal -> Light -> Glass -> Speed -> Soak
7. Then press “START/RESET” to start the dishwasher.

NOTE: When you press “START/RESET” button to pause during washing, the LED display will stop blinking and the dishwasher will beep every minute unless you press “START/RESET” to start.

Changing the cycle:

You can modify the washing cycle when the dishwasher runs for a short time. Otherwise, the detergent may have already been released and the appliance may have already drained the wash water. If this is the case, the detergent dispenser must be refilled (see p. 9).

Press “START/RESET” and hold for 3 seconds until the machine moves into standby mode. Then you can change the program to the desired cycle setting.

NOTE: If you open the door during washing, the machine will pause. When you close the door and press the “START/RESET” button, the machine will resume after 10 seconds.

The LED display shows the state of the dishwasher:

- LED display off.....machine is on standby
- LED display on.....machine is on pause
- Colon icon is blinking.....machine is running

Forget to add a dish?

A forgotten dish can be added any time before the detergent cup opens.

1. Press “START/RESET” to pause
2. Open the door partially to stop washing
3. After the spray arms stop, open the door completely
4. Add forgotten dishes and close the door
5. Press “START/RESET” and the dishwasher will continue its cycle after 10 seconds

At the end of the wash cycle:

When the working cycle has finished, the buzzer of the dishwasher will sound for 8 seconds, then stop. Turn off the appliance using the ON/OFF button, shut off the water supply and open the door of the dishwasher. Wait a few minutes before unloading the dishwasher to avoid handling the dishes and utensils while they are still hot and more susceptible to breakage. They will also dry better.

1. Switch off the dishwasher

All of the phase lights are off, only in this case, the cycle has ended

- Switch off the dishwasher by pressing the ON/OFF button.
- Turn off the water tap.

2. Open the door carefully

Hot dishes are sensitive to knocks. The dishes should therefore be allowed to cool down (for around 15 minutes) before removing from the appliance.

- Open the dishwasher's door, leave it ajar and wait a few minutes before removing the dishes. The dishes will be able to cool off and the drying will be improved.

3. Unloading the dishwasher

It is normal that the dishwasher is wet inside.

WARNING: It is dangerous to open the door when washing, because the hot water may scald you.

Cleaning and Care

Filtering System:

The filter prevents larger remnants of food or other objects from getting inside the pump. The filtering system consists of a coarse filter, a flat (main) filter and a micro filter.

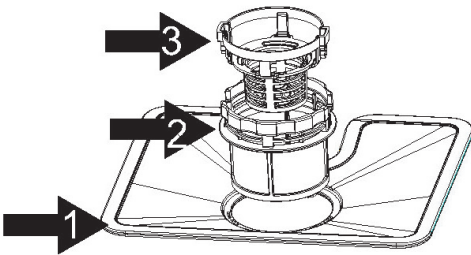

(1) Main filter: Food and soil particles trapped by this filter are pulverized by a special jet on the spray arm and washed down the drain.

(2) Fine filter: This filter holds soil and food residue in the sump area and prevents it from being redeposited on the dishes during the wash cycle.

(3) Coarse filter: Larger items (pieces of glass or bone) that could block the drain are trapped in this filter. To remove the trapped items, gently squeeze the tap on the top of this filter and lift out.

Filtering Assembly:

The filter efficiently removes food particles from the wash water, allowing it to be recycled during the cycle. For best performance and results, the filter assembly must be cleaned regularly. For this reason, it is a good idea to remove the larger particles trapped in the filter after each wash cycle by rinsing the filter and cup under running water. To remove the filter assembly, pull on the cup handle in the upward direction.

WARNING:

1. NEVER run the dishwasher without the filters in place.
2. Improper replacement of the filter may reduce the performance level of the appliance and damage dishes and utensils.

Removing the filter assembly:

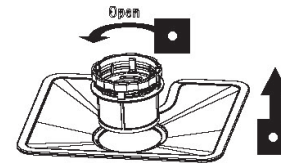

Step 1: Unscrew the fine filter by turning counter-clockwise.

Step 2: Lift up the fine filter.

Step 3: Lift up the main filter.

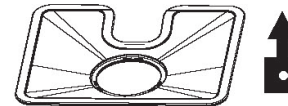

NOTE: If you follow the steps from 1–3, the filter system will be removed. If you reverse the directions from 3–1, the filter system will be installed.

- Inspect the filters for blockages every time the dishwasher has been used.
- By unscrewing the coarse filter, you can remove the filter system. Remove any food remnants and clean the filters under running water.

The entire filter assembly should be cleaned once a week.

Cleaning the filter:

To clean the coarse and fine filters, use a cleaning brush. Reassemble the filter parts as shown in the figure above and reinsert the entire assembly in the dishwasher.

WARNING: When cleaning the filters, don't knock on them. Otherwise, the filters could be contorted and could result in poor performance of the dishwasher.

Caring for the dishwasher:

1. The control panel can be cleaned by using a lightly dampened cloth and drying thoroughly.
2. To clean the exterior, use a good appliance polishing wax.
3. NEVER use sharp objects, scouring pads or harsh cleaners on any part of the dishwasher.

Cleaning the door:

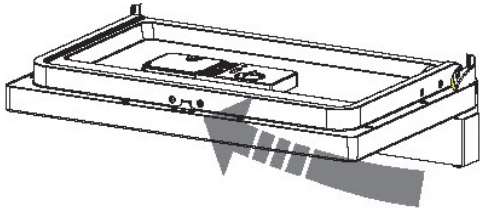

To clean the edge around the door, you should only use a soft, warm damp cloth. To avoid penetration of water into the door lock and electrical components, do NOT use a spray cleaner of any kind.

WARNING:

NEVER use a spray cleaner to clean the door panel as it may damage the door lock and electrical components. Abrasive agents and some paper towels should not be used because of the risk of scratching or leaving spots on the stainless steel surface.

Protect against Freezing:

Please take frost protection measures on the dishwasher in winter. After every washing cycle, follow these steps:

1. Cut off electrical power to the dishwasher
2. Turn off the water supply and disconnect the water inlet pipe from the water valve
3. Drain water from the inlet pipe and water valve (use a pan to catch the water)
4. Reconnect the water inlet pipe to the water valve
5. Remove the filter at the bottom of the tub and use a sponge to soak up water in sump

NOTE: If your dishwasher does not work because of ice, please contact a professional service person.

Cleaning the spray arms:

The spray arms should be removed for periodic cleaning of the nozzles to prevent possible clogging. Wash them under running water and carefully replace them, checking that their rotary movement is in no way impeded.

Grasp the middle of the spray arm, pull it upwards to remove it. Wash the arms under a jet of running water and carefully replace them. After reassembly, check that the spray arms turn freely.

How to keep your dishwasher in shape:

• After every wash

After every wash, turn off the water supply to the appliance and leave the door slightly open so that moisture and odors are not trapped inside.

• Remove the plug

Before cleaning or performing maintenance, always unplug from the wall outlet.

• No solvents or abrasive cleaners

To clean the exterior and rubber parts of the dishwasher, do NOT use solvents or abrasive cleaning products. Only use a cloth with warm soapy water. To remove spots or stains from the surface of the interior, use a cloth dampened with water and a little vinegar, or a cleaning product made specially for dishwashers.

• When it is not in use for a long period of time

It is recommended that you run a wash cycle with the dishwasher empty and then remove the plug from the socket. Turn off the water supply and leave the door of the appliance slightly open. This will help the door seals to last longer and prevent odors from forming within the appliance.

• Moving the appliance

If the appliance must be moved, try to keep it in the vertical position. If absolutely necessary, it can be positioned on its back.

• Seals

One of the factors that causes odors to form in the dishwasher is food that remains trapped in the seals. Periodic cleaning with a damp sponge will prevent this from occurring.

Installation

The installation of the pipes and electrical equipment should be done by professionals.

WARNING: Electrical Shock Hazard

Disconnect electrical power before installing the dishwasher. Failure to do so could result in electrical shock.

Installation preparation

- The installation position of the dishwasher should be near the existing inlet and drain hoses and power cord.
- One side of the cabinet sink should be chosen to facilitate the connection of the drain hoses of the dishwasher.

Positioning the appliance

Position the appliance in the desired location. The back should rest against the wall behind it, and the sides should rest along the adjacent cabinets or wall. The dishwasher is equipped with water supply and drain hoses that can be positioned to the right or the left to facilitate proper installation.

About the power connection

WARNING! For personal safety:

- Do NOT use an extension cord or an adapter plug with this appliance.
- Do NOT, under any circumstances, cut or remove the grounding connection from the power cord.

Electrical requirements

Please look at the rating label to know the rating voltage and connect the dishwasher to the appropriate power supply. Use the required 10 amp fuse, time delay fuse or recommended circuit breaker and provide a separate circuit that serves only this appliance.

Ensure that proper grounding exists before use!

Electrical connection

Ensure the voltage and frequency of the power corresponds to those on the rating plate. Only insert the plug into a properly grounded electrical socket. If the electrical socket to which the appliance must be connected is not appropriate for the plug, replace the socket rather than using adapters as they could cause overheating and burns.

Installation (cont'd)

Water Connection

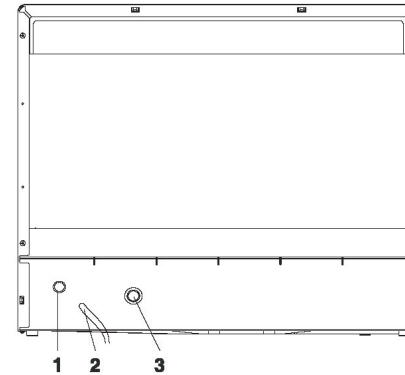

Rear of Dishwasher:

1. Drain Port
2. Power Cord
3. Inlet Port

Your dishwasher comes equipped with a 'quick connect' assembly (includes inlet and drain hose). The faucet adapter (5) must be installed on the faucet before you can connect the dishwasher. This adapter is included inside your dishwasher. The faucet adapter (5) is compatible with faucets either male (outside) or female (inside) threaded faucet connections. Make sure the gasket (6) is seated properly inside the faucet adapter (5).

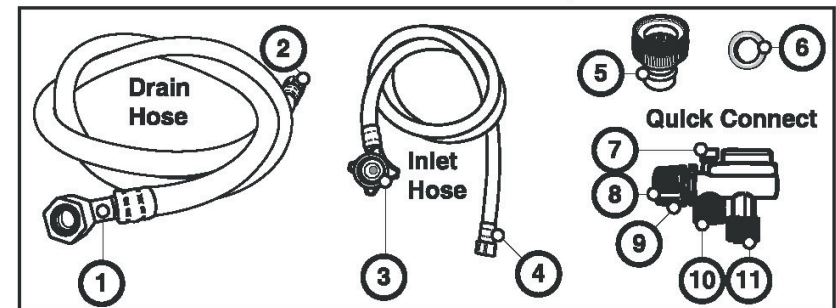

Quick Connect Assembly

Drain Hose:

1. Drain Port connection
2. Quick Connect connection

Inlet Hose:

3. Inlet Port connection
4. Quick Connect connection

Faucet Adapter:

5. Faucet Adapter (55/64-27 internal threads, 15/16-27 external threads)
6. Faucet Washer

Quick Connect:

7. Pressure Relief Valve
8. Faucet Adapter connection
9. Locking Collar
10. Inlet Hose connection
11. Drain Hose connection

In order to avoid water from collecting in the inlet hose, turn off the faucet after use.

1. Remove the aerator from the faucet. Thread the faucet adapter with gasket onto (or into) the faucet tap. If leaks occur, tighten with vice-grips, do not over-tighten. Use thread tape if needed.
2. Connect the 6-sided connection of the drain hose (1) to the drain port connection (1) on the back of the dishwasher cabinet. Do NOT over-tighten (to avoid damage to the thread).
3. Connect the star-shaped connection of the inlet hose (3) to the inlet port (3) on the back of the dishwasher cabinet. Do NOT over-tighten (to avoid damage to the thread).
4. Connect the circular connection of the drain hose onto the longer (bottom) male connection on the quick connect (11).
5. Connect the circular connection of the inlet hose onto the shorter (top) male connection on the quick connect (10).
6. Attach the quick connect onto the faucet adapter by pulling down the outer locking collar on the quick connect while pushing the quick connect upward onto the faucet adapter.
7. When the quick connect snaps onto the faucet adapter, release the locking collar. Verify that the connection is secure.
8. Slowly open the hot water line and check for any sign of water leaks at all hose connections. If leaks are located, immediately close the water supply and repair the hose connections.

IMPORTANT:

1. Once you open the water supply line (even if it is closed immediately thereafter), the inlet hose will be pressurized.
2. To relieve water pressure from inside the inlet hose (make sure the water line (faucet) is off): press and hold the red pressure release button on the quick connect until the flow of water stops.

WARNING:

FAILURE TO RELIEVE WATER PRESSURE BEFORE DISCONNECTING THE QUICK CONNECT FROM THE FAUCET WILL RESULT IN BACK-PRESSURE OVER-SPRAY. THE TEMPERATURE OF INCOMING WATER CAN BE VERY HOT AND BACK-PRESSURE OVER-SPRAY COULD CAUSE SEVERE BURNS AND/OR SCALDING.

DANGER:

DO NOT LET CHILDREN DISCONNECT THE DISHWASHER; CLOSE SUPERVISION OF CHILDREN IS ALWAYS IMPORTANT AROUND APPLIANCES.

NOTE

Hard water conditions will adversely affect the washing performance of your dishwasher. Hard water conditions will also contribute to 'lime' (white film substance) deposits and/or 'scaling' on the stainless steel surface of the dishwasher tub and heating element (located in the sump underneath the removable filter screen). To assist in minimizing these conditions, it is recommended to periodically operate/rinse the inside of the dishwasher (empty) using 1 cup of white vinegar at least once a week.

Disconnecting your dishwasher

1. Shut off the water supply at the faucet.
2. Disconnect the power supply cord.

Before Using Your Dishwasher

Check the following before starting the dishwasher:

1. The dishwasher is level and fixed properly.
2. The inlet valve is open.
3. The hose connections on the dishwasher and faucet need to be on tight to prevent leaking.
4. The wires are tightly connected.
5. The power is switched on.
6. The inlet and drain hoses are not knotted.
7. All packaging materials have been removed from inside the dishwasher.

ATTENTION: After installation, please make sure to keep this manual.

Troubleshooting

Before calling for service, review the chart on the following pages:

PROBLEM	POSSIBLE CAUSES	WHAT TO DO
Dishwasher doesn't start	Blown fuse or the circuit breaker has been tripped	Replace fuse or reset circuit breaker. Remove any other appliances sharing the same circuit as the dishwasher.
	Power supply isn't turned on	Make sure the dishwasher is turned on and the door is closed securely. Make sure the power cord is properly plugged into the wall socket.
	Door isn't properly closed	Close the dishwasher, making sure the door latches.
Water not pumped from dishwasher	Kink in drain hose	Check the drain hose.
	Filter clogged	Check the coarse filter (see p. 15).
	Kitchen sink clogged	Check the kitchen sink to make sure it is draining well. If the problem is the kitchen sink, call a plumber.
Suds in the tub	Improper detergent	Only use detergent specifically made for dishwashers to avoid suds. If suds occur, open the door and let the suds evaporate. Add 1 gal. of cold water to the tub. Close and latch the door, then start the "Soak" cycle to drain out the water. Repeat if necessary.
	Spilled rinse-aid	Always wipe up rinse-aid spills immediately.
Stained tub interior	Detergent with colorant was used	Make sure that the detergent is one without colorant

Troubleshooting (cont'd)

Continued from the previous page:

PROBLEM	POSSIBLE CAUSES	WHAT TO DO
White film on the inside surface	Hard water minerals	To clean the interior, use a damp sponge with dishwasher detergent and wear rubber gloves. Never use any other cleaner than dishwasher detergent for the risk of foaming or suds.
There are rust stains on cutlery	The affected items are not corrosion-resistant	Place only corrosion-resistant cutlery in the dishwasher.
	A program was not run after dishwasher salt was added; traces of salt have gotten into the wash cycle	Always run the "Quick" wash cycle without any crockery in the dishwasher and without selecting the "Turbo" function after adding dishwasher salt.
	The lid of the softener is loose	Check the lip. Ensure the fix is fine.
Knocking noise in the wash cabinet	The spray arm is knocking against an item in a basket	Interrupt the cycle and rearrange the items that are obstructing the spray arm.
Rattling noise in the wash cabinet	Items of crockery are insecure in the wash cabinet	Interrupt the cycle and rearrange the items of crockery.
Knocking noise in the water pipes	This may be caused by on-site installation or the cross-section of the piping	This has no influence on dishwasher function. If in doubt, contact a suitably qualified plumber.
Cloudiness on glassware	Combination of soft water and too much detergent	Use less detergent if you have soft water and select a shorter cycle to wash the glassware.
Black or gray marks on dishes	Aluminum utensils have rubbed against the dishes	Use a mild abrasive cleaner to eliminate those marks.
Detergent left in dispenser cups	Dishes block detergent cups	Reload the dishwasher using "Loading the Dishwasher" on p. 10–11.

Continued from previous pages:

PROBLEM	POSSIBLE CAUSES	WHAT TO DO
Dishes are not clean	The dishes were not loaded correctly	See notes in "Loading the Dishwasher" on p. 10–11.
	The cycle was not powerful enough	Select a more intensive cycle. See "Wash Cycle Table" on p. 12.
	Not enough detergent was dispensed	Use more detergent; or change your detergent.
	Items are blocking the path of the spray arms	Rearrange the items so that the spray arms can rotate freely.
	The filter combination in the base of the wash cabinet is not clean or correctly fitted; this may cause the spray arm jets to get blocked	Clean and/or fit the filter combination correctly. Clean the spray arms jets. See "Cleaning the Spray Arms" on p. 17.
The dishes are not drying	Improper loading	Load the dishwasher as suggested on p. 10–11.
	Too little rinse-aid	Increase the amount of rinse-aid OR refill the rinse-aid dispenser.
	Dishes are removed too soon	Open the dishwasher door and leave it ajar for a few minutes before removing the dishes. They will be cooler and dryer if you wait.
	Wrong cycle selection	In short cycles, the washing temperature is lower, resulting in a lower cleaning performance. Choose a program with a longer cleaning cycle.
	Using cutlery with a low-quality coating	Water drainage is more difficult with these items. Cutlery or dishes of this type are not suitable for washing in the dishwasher.

When there are certain malfunctions within the dishwasher, the display will show error codes to warn you:

Code	Meaning	Possible Causes
E1	Longer inlet time	Faucet is not opened or water intake is restricted or water pressure is too low.
E4	Overflow	Some element of the dishwasher has a leak.

If any item, for any reason, does not meet your expectations, just return it to us.

We'll gladly either:

- Refund your merchandise amount
- Credit your account
- Send a replacement

You can return any unused item in its original packaging within 60 days of its receipt for a full refund of the purchase price (excluding shipping and handling charges).

Please send returns to:

**Montgomery Ward, Inc.
Attn: Customer Returns
2000 Harrison Suite 100
Clinton, IA 52732-6676**

When returning an item:

- Use the original packaging and pack it securely.
- Please adequately insure your item in case you need to make a claim with the carrier you choose for returning your item.
- Include your order number and reason for return.
- We recommend keeping the receipt for 4 weeks.

Montgomery Ward®
Improving American Homes Since 1872

1 Year Limited Warranty

Montgomery Ward, Inc. warrants this product to be free from defects in material and workmanship for one year from provable date of purchase.

Within this warranty period, Montgomery Ward will repair or replace, at its option, defective parts of this product at no charge, provided the product is returned, freight prepaid with proof of purchase to Montgomery Ward. Allow 2-4 weeks for return shipping.

This warranty does not cover improper installation, misuse, abuse or neglect on part of the owner. Warranty is also invalid in any case that the product is taken apart or serviced by an unauthorized service station.

This warranty gives you specific legal rights and they may vary from state to state.

THE FOREGOING WARRANTIES ARE IN LIEU OF ALL OTHER WARRANTIES AND CONDITIONS, EXPRESS OR IMPLIED, INCLUDING BUT NOT LIMITED TO THOSE OF MERCHANTABILITY OR FITNESS FOR A PARTICULAR PURPOSE.

Montgomery Ward Customer Service
8:00 am to Midnight CST, Monday through Friday

Wards.com 1-888-557-3848